

SPECIFICATIONS FOR NICHIA CHIP TYPE WHITE LED

MODEL : NSSW105T

NICHIA CORPORATION

1.SPECIFICATIONS

(1) Absolute Maximum Ratings (Ta=25°C)

Item	Symbol	Absolute Maximum Rating	Unit
Forward Current	I _F	30	mA
Pulse Forward Current	I _{FP}	100	mA
Reverse Voltage	V _R	5	V
Power Dissipation	P _D	105	mW
Operating Temperature	T _{opr}	-30 ~ + 85	°C
Storage Temperature	T _{stg}	-40 ~ +100	°C
Soldering Temperature	T _{sld}	Reflow Soldering : 260°C for 10sec. Hand Soldering : 350°C for 3sec.	

I_{FP} Conditions : Pulse Width ≤ 10msec. and Duty ≤ 1/10

(2) Initial Electrical/Optical Characteristics (Ta=25°C)

Item	Symbol	Condition	Typ.	Max.	Unit
Forward Voltage	V _F	I _F =20[mA]	(3.2)	3.5	V
Reverse Current	I _R	V _R = 5[V]	-	50	μA
Luminous Intensity (Chromaticity Coordinate 1)	I _v	I _F =20[mA]	(1.95)	-	cd
Chromaticity Coordinate 1*	x	I _F =20[mA]	0.310	-	-
	y	I _F =20[mA]	0.320	-	-
Luminous Intensity (Chromaticity Coordinate 2)	I _v	I _F =20[mA]	(1.85)	-	cd
Luminous Flux (Chromaticity Coordinate 2)	φ _v	I _F =20[mA]	(5.0)		lm
Chromaticity Coordinate 2*	x	I _F =20[mA]	0.300	-	-
	y	I _F =20[mA]	0.295	-	-

* Please refer to CIE 1931 chromaticity diagram.

(3) Ranking (Ta=25°C)

Item	Symbol	Condition	Min.	Max.	Unit	
Luminous Intensity	Rank A20	I _v	I _F =20[mA]	2.00	2.10	cd
	Rank A19	I _v	I _F =20[mA]	1.90	2.00	cd
	Rank A18	I _v	I _F =20[mA]	1.80	1.90	cd
	Rank A17	I _v	I _F =20[mA]	1.70	1.80	cd
	Rank A16	I _v	I _F =20[mA]	1.60	1.70	cd
	Rank A15	I _v	I _F =20[mA]	1.50	1.60	cd

* Luminous Intensity Measurement allowance is ± 7%.

Color Ranks

(I_F=20mA, Ta=25°C)

Rank a52				
x	0.2800	0.2720	0.2820	0.2880
y	0.2480	0.2580	0.2720	0.2620

Rank a56				
x	0.2830	0.2800	0.2880	0.2910
y	0.2440	0.2480	0.2620	0.2580

Rank a57			
x	0.2720	0.2793	0.2820
y	0.2580	0.2755	0.2720

Rank a62				
x	0.2880	0.2820	0.2910	0.2960
y	0.2620	0.2720	0.2870	0.2760

6.RELIABILITY

(1) TEST ITEMS AND RESULTS

Test Item	Standard Test Method	Test Conditions	Note	Number of Damaged
Resistance to Soldering Heat (Reflow Soldering)	JEITA ED-4701 300 301	Tsld=260°C, 10sec. (Pre treatment 30°C,70%,168hrs.)	2 times	0/50
Solderability (Reflow Soldering)	JEITA ED-4701 300 303	Tsld=215 ± 5°C, 3sec. (Lead Solder)	1 time over 95%	0/50
Thermal Shock	JEITA ED-4701 300 307	0°C ~ 100°C 15sec. 15sec.	20 cycles	0/50
Temperature Cycle	JEITA ED-4701 100 105	-40°C ~ 25°C ~ 100°C ~ 25°C 30min. 5min. 30min. 5min.	100 cycles	0/50
Moisture Resistance Cyclic	JEITA ED-4701 200 203	25°C ~ 65°C ~ -10°C 90%RH 24hrs./1cycle	10 cycles	0/50
High Temperature Storage	JEITA ED-4701 200 201	Ta=100°C	1000 hrs.	0/50
Temperature Humidity Storage	JEITA ED-4701 100 103	Ta=60°C, RH=90%	1000 hrs.	0/50
Low Temperature Storage	JEITA ED-4701 200 202	Ta=-40°C	1000 hrs.	0/50
Steady State Operating Life Condition 1		Ta=25°C, IF=20mA	1000 hrs.	0/50
Steady State Operating Life Condition 2		Ta=25°C, IF=30mA	500 hrs.	0/50
Steady State Operating Life of High Temperature		Ta=85°C, IF=8.5mA	1000 hrs.	0/50
Steady State Operating Life of High Humidity Heat		60°C, RH=90%, IF=15mA	500 hrs.	0/50
Steady State Operating Life of Low Temperature		Ta=-30°C, IF=20mA	1000 hrs.	0/50
Vibration	JEITA ED-4701 400 403	100 ~ 2000 ~ 100Hz Sweep 4min. 200m/s ² 3directions, 4cycles	48min.	0/50
Substrate Bending	JEITA ED-4702	3mm, 5 ± 1 sec.	1 time	0/50

(2) CRITERIA FOR JUDGING DAMAGE

Item	Symbol	Test Conditions	Criteria for Judgement	
			Min.	Max.
Forward Voltage	V _F	I _F =20mA	-	U.S.L.*) × 1.1
Reverse Current	I _R	V _R =5V	-	U.S.L.*) × 2.0
Luminous Intensity	I _V	I _F =20mA	L.S.L.***) × 0.7	-

*) U.S.L. : Upper Standard Level

**) L.S.L. : Lower Standard Level

7.CAUTIONS

The LEDs are devices which are materialized by combining Blue LEDs and special phosphors. Consequently, the color of the LEDs is changed a little by an operating current. Care should be taken after due consideration when using LEDs.

(1) Moisture Proof Package

- When moisture is absorbed into the SMT package it may vaporize and expand during soldering. There is a possibility that this can cause exfoliation of the contacts and damage to the optical characteristics of the LEDs. For this reason, the moisture proof package is used to keep moisture to a minimum in the package.
- The moisture proof package is made of an aluminum moisture proof bag. A package of a moisture absorbent material (silica gel) is inserted into the aluminum moisture proof bag. The silica gel changes its color from blue to pink as it absorbs moisture.

(2) Storage

· Storage Conditions

Before opening the package :

The LEDs should be kept at 30°C or less and 90%RH or less. The LEDs should be used within a year. When storing the LEDs, moisture proof packaging with absorbent material (silica gel) is recommended.

After opening the package :

The LEDs should be kept at 30°C or less and 70%RH or less. The LEDs should be soldered within 168 hours (7days) after opening the package. If unused LEDs remain, they should be stored in moisture proof packages, such as sealed containers with packages of moisture absorbent material (silica gel). It is also recommended to return the LEDs to the original moisture proof bag and to reseal the moisture proof bag again.

- If the moisture absorbent material (silica gel) has faded away or the LEDs have exceeded the storage time, baking treatment should be performed using the following conditions.
Baking treatment : more than 24 hours at $65 \pm 5^{\circ}\text{C}$
- This product has silver plated metal parts that are inside and/or outside the package body. The silver plating becomes tarnished when being exposed to an environment which contains corrosive gases. Any LED with tarnished leads may lead to poor solderability and deterioration of optical characteristics. Please do not expose the LEDs to corrosive atmosphere during storage.
- After assembly and during use, silver plating can be affected by the corrosive gases emitted by components and materials in close proximity of the LEDs within an end product, and the gases entering into the product from the external atmosphere. The above should be taken into consideration when designing.
- Please avoid rapid transitions in ambient temperature, especially in high humidity environments where condensation can occur.

(3) Heat Generation

- Thermal design of the end product is of paramount importance. Please consider the heat generation of the LED when making the system design. The coefficient of temperature increase per input electric power is affected by the thermal resistance of the circuit board and density of LED placement on the board, as well as other components. It is necessary to avoid intense heat generation and operate within the maximum ratings given in this specification.
- The operating current should be decided after considering the ambient maximum temperature of LEDs.

(4) Soldering Conditions

- The LEDs can be soldered in place using the reflow soldering method. Nichia cannot make a guarantee on the LEDs after they have been assembled using the dip soldering method.
- Recommended soldering conditions

	Reflow Soldering		Hand Soldering	
	Lead Solder	Lead-free Solder	Temperature	350°C Max.
Pre-heat	120 ~ 150°C	180 ~ 200°C	Soldering time	3 sec. Max.
Pre-heat time	120 sec. Max.	120 sec. Max.		(one time only)
Peak temperature	240°C Max.	260°C Max.		
Soldering time	10 sec. Max.	10 sec. Max.		
Condition	refer to Temperature - profile ①.	refer to Temperature - profile ②. (N ₂ reflow is recommended.)		

* Although the recommended soldering conditions are specified in the above table, reflow or hand soldering at the lowest possible temperature is desirable for the LEDs.

* A rapid-rate process is not recommended for cooling the LEDs down from the peak temperature.

[Temperature-profile (Surface of circuit board)]

Use the conditions shown to the under figure.

<① : Lead Solder>

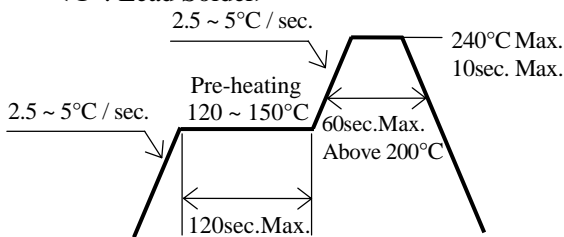

<② : Lead-free Solder>

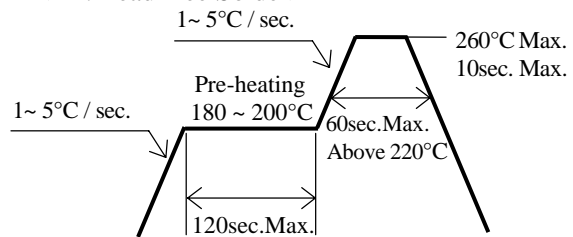

[Recommended soldering pad design]

Use the following conditions shown in the figure.

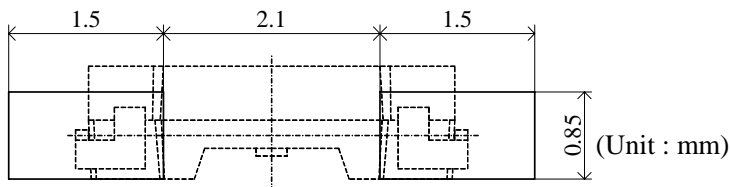

- Occasionally there is a brightness decrease caused by the influence of heat or ambient atmosphere during air reflow. It is recommended that the User use the nitrogen reflow method.
- Repairing should not be done after the LEDs have been soldered. When repairing is unavoidable, a double-head soldering iron should be used. It should be confirmed beforehand whether the characteristics of the LEDs will or will not be damaged by repairing.
- Reflow soldering should not be done more than two times.
- When soldering, do not put stress on the LEDs during heating.
- After soldering, do not warp the circuit board.

(5) Cleaning

- It is recommended that isopropyl alcohol be used as a solvent for cleaning the LEDs. When using other solvents, it should be confirmed beforehand whether the solvents will dissolve the package and the resin or not. Freon solvents should not be used to clean the LEDs because of worldwide regulations.
- Do not clean the LEDs by the ultrasonic. When it is absolutely necessary, the influence of ultrasonic cleaning on the LEDs depends on factors such as ultrasonic power and the assembled condition. Before cleaning, a pre-test should be done to confirm whether any damage to the LEDs will occur.

(6) Static Electricity

- Static electricity or surge voltage damages the LEDs.
It is recommended that a wrist band or an anti-electrostatic glove be used when handling the LEDs.
- All devices, equipment and machinery must be properly grounded. It is recommended that precautions be taken against surge voltage to the equipment that mounts the LEDs.
- When inspecting the final products in which LEDs were assembled, it is recommended to check whether the assembled LEDs are damaged by static electricity or not. It is easy to find static-damaged LEDs by a light-on test or a VF test at a lower current (below 1mA is recommended).
- Damaged LEDs will show some unusual characteristics such as the leak current remarkably increases, the forward voltage becomes lower, or the LEDs do not light at the low current.

Criteria : (VF > 2.0V at IF=0.5mA)

(7) Others

- NSSW105 complies with RoHS Directive.
- Care must be taken to ensure that the reverse voltage will not exceed the absolute maximum rating when using the LEDs with matrix drive.
- The LED light output is strong enough to injure human eyes. Precautions must be taken to prevent looking directly at the LEDs with unaided eyes for more than a few seconds.
- Flashing lights have been known to cause discomfort in people; you can prevent this by taking precautions during use. Also, people should be cautious when using equipment that has had LEDs incorporated into it.
- The LEDs described in this brochure are intended to be used for ordinary electronic equipment (such as office equipment, communications equipment, measurement instruments and household appliances). Consult Nichia's sales staff in advance for information on the applications in which exceptional quality and reliability are required, particularly when the failure or malfunction of the LEDs may directly jeopardize life or health (such as for airplanes, aerospace, submersible repeaters, nuclear reactor control systems, automobiles, traffic control equipment, life support systems and safety devices).
- User shall not reverse engineer by disassembling or analysis of the LEDs without having prior written consent from Nichia. When defective LEDs are found, the User shall inform Nichia directly before disassembling or analysis.
- The formal specifications must be exchanged and signed by both parties before large volume purchase begins.
- The appearance and specifications of the product may be modified for improvement without notice.

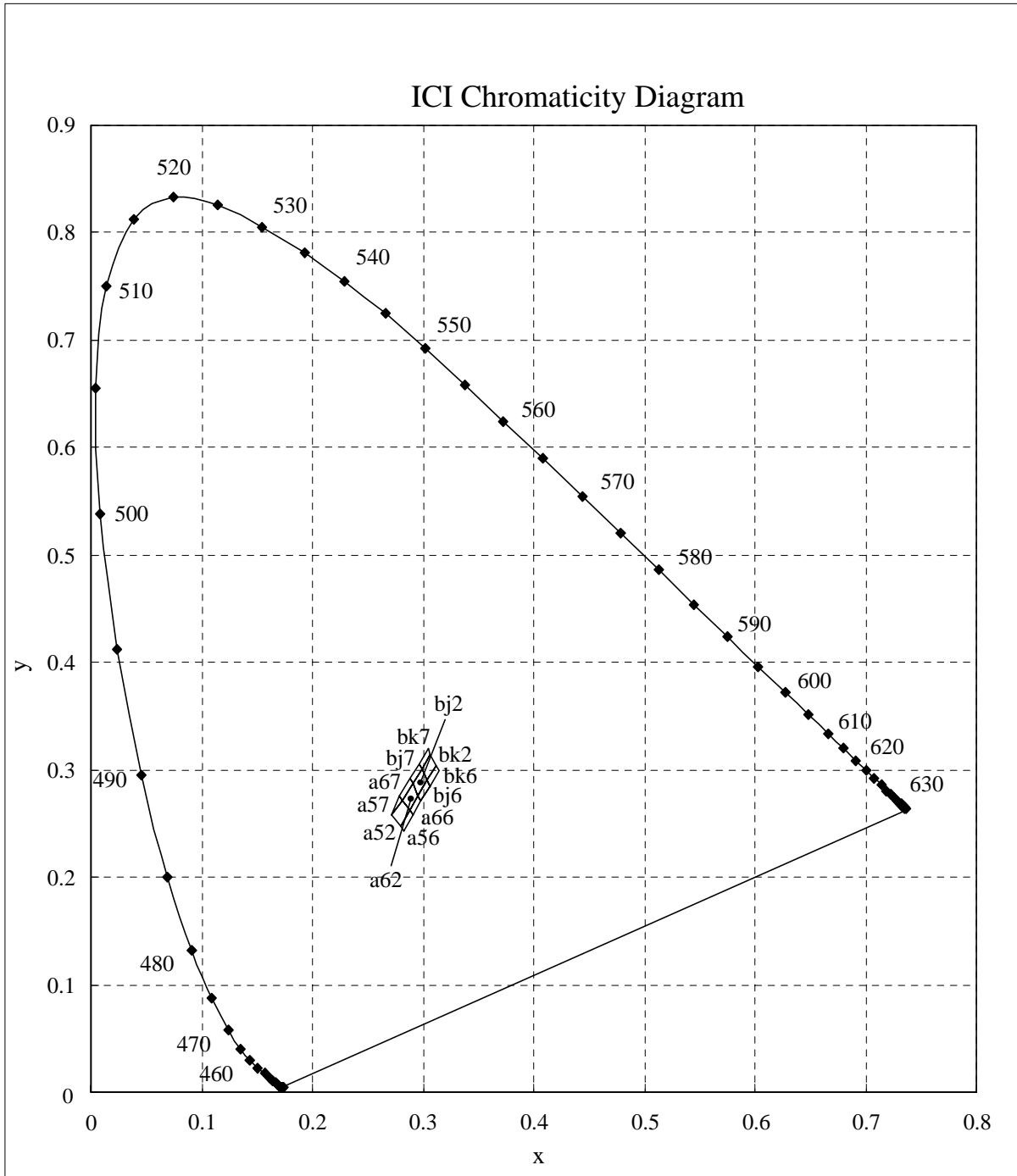

* Color Coordinates Measurement allowance is ± 0.005 .

■ Forward Voltage vs. Forward Current

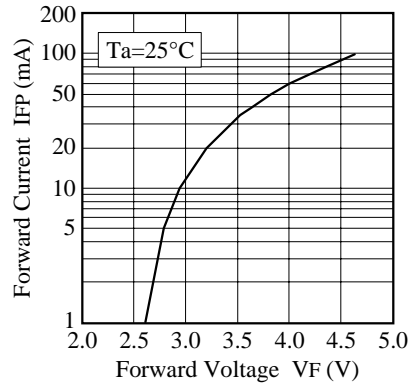

■ Forward Current vs. Relative Luminosity

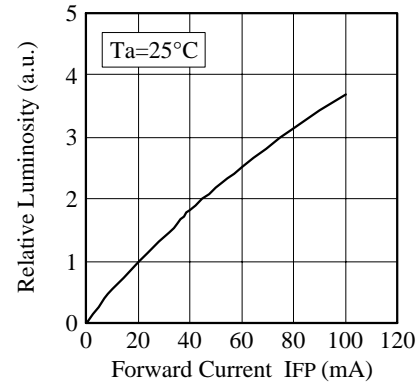

■ Duty Ratio vs. Allowable Forward Current

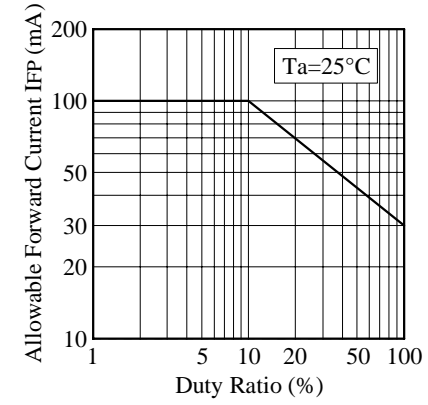

■ Ambient Temperature vs. Forward Voltage

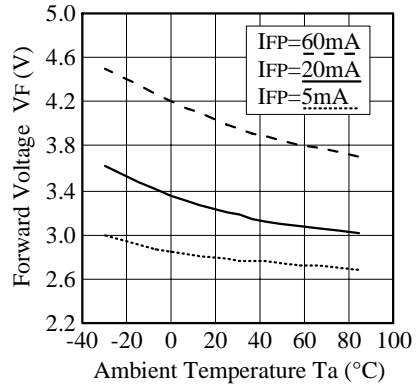

■ Ambient Temperature vs. Relative Luminosity

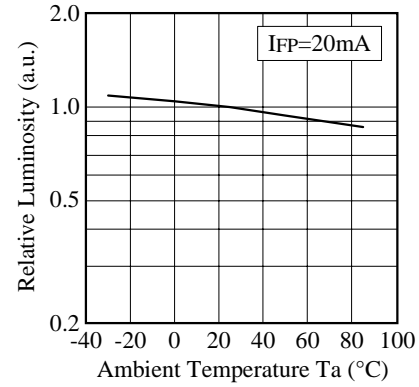

■ Ambient Temperature vs. Allowable Forward Current

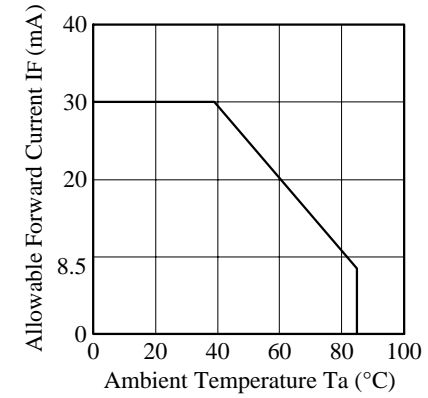

NICHIA CORPORATION	Model	NSSW105
	Title	CHARACTERISTICS
	No.	070705768411

■ Forward Current vs. Chromaticity Coordinate

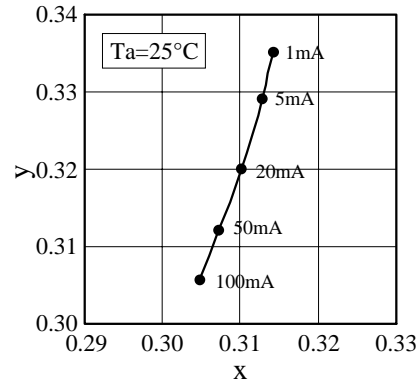

■ Spectrum

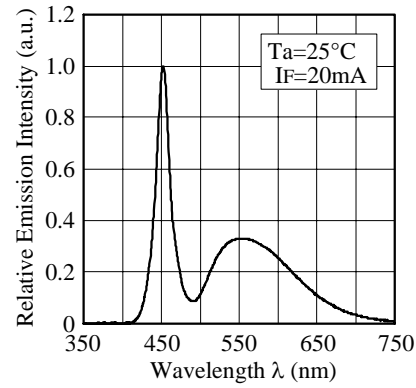

■ Ambient Temperature vs. Chromaticity Coordinate

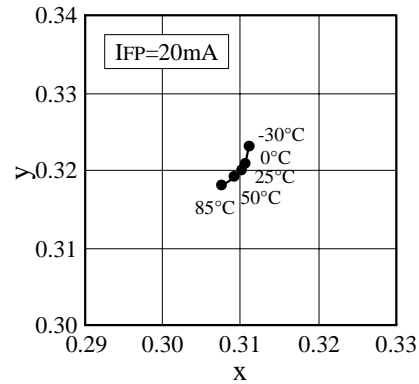

■ Directivity

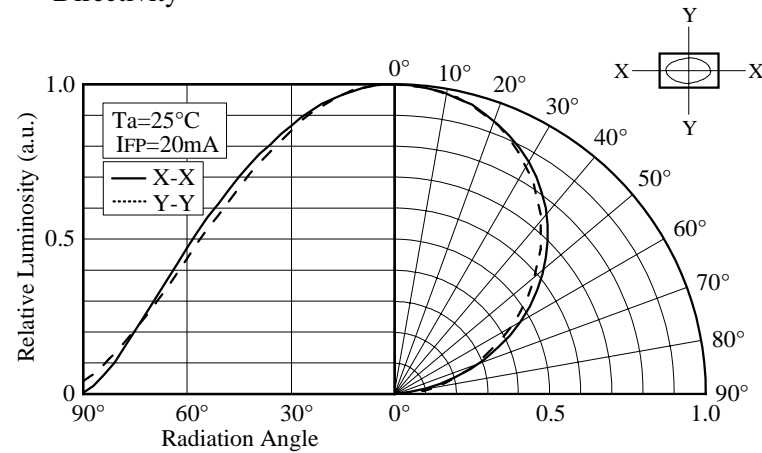

NICHIA CORPORATION	Model	NSSW105
	Title	CHARACTERISTICS
	No.	070705768421

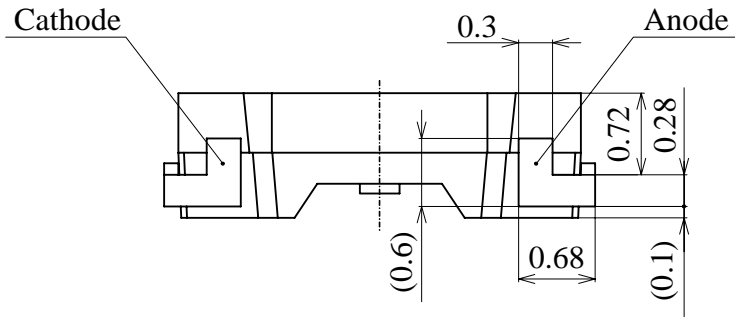
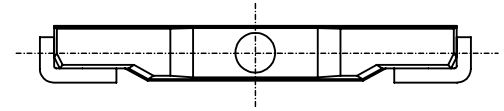
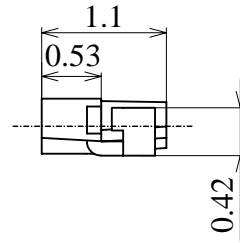
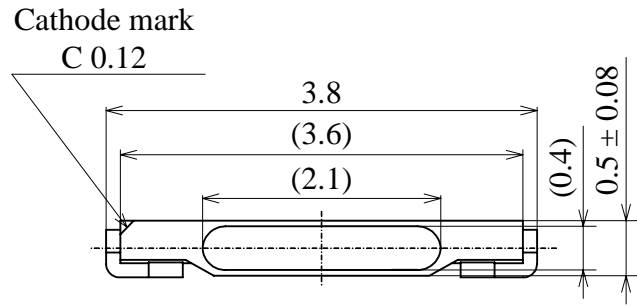
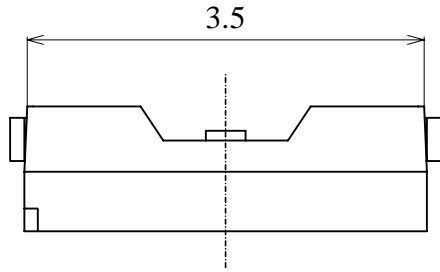

(NOTE) The LED may have flash/flange which exceeds the tolerance of this print.

ITEM	MATERIALS
PACKAGE	Heat-Resistant Polymer
ENCAPSULATING RESIN	Silicone Resin (with Diffused + Phosphor)
ELECTRODES	Ag Plating Copper Alloy

NICHIA CORPORATION	Model	NSSW105	Unit mm
	Title	OUTLINE DIMENSIONS	
	No.	070705768431	Allow ±0.1

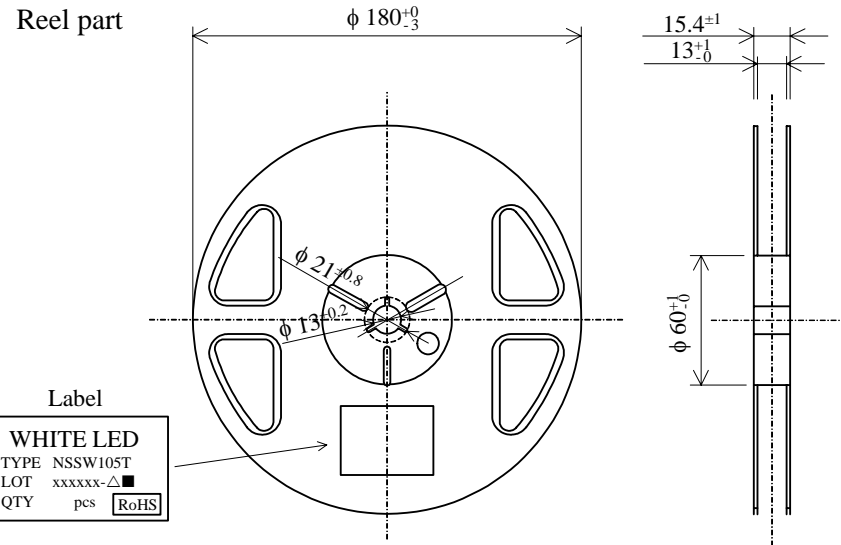
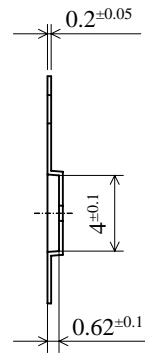
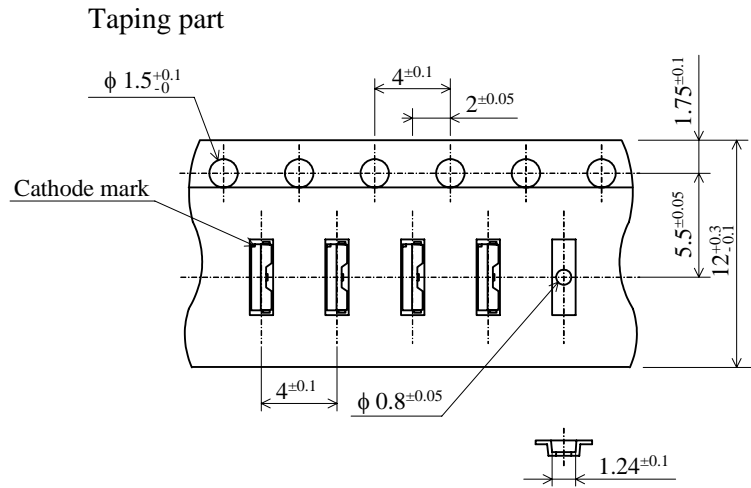

Reel end of tape

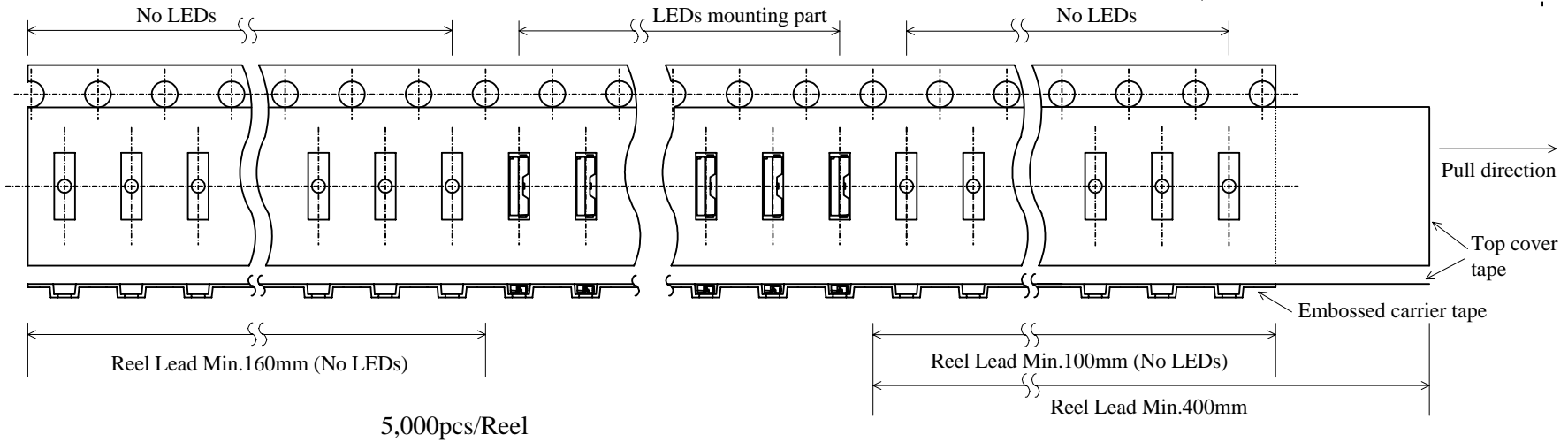

Taping is based on the **JIS C 0806** : Packaging of Electronic Components on Continuous Tapes.

NICHIA CORPORATION

Model	NSSW105T	Unit mm
Title	TAPING DIMENSIONS	
No.	070705768441	Scale Allow

The reel and moisture absorbent material are put in the moisture proof foil bag and then heat sealed.

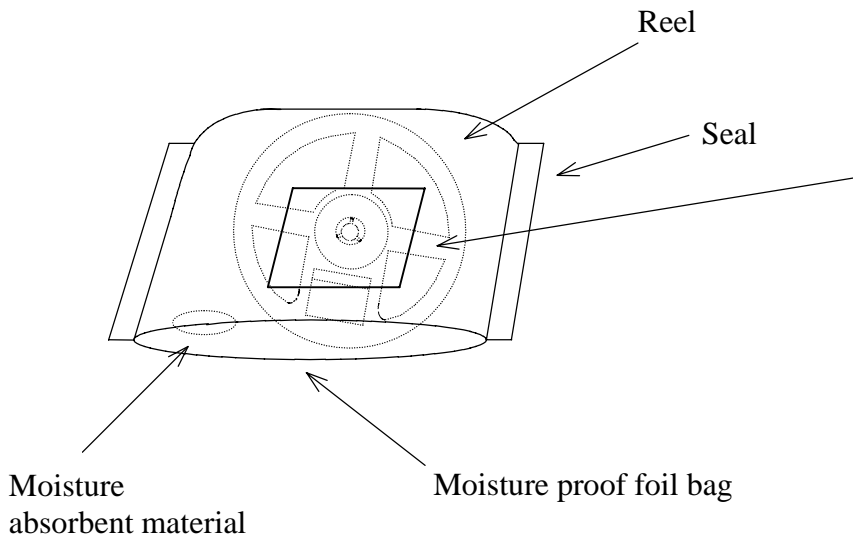

Label

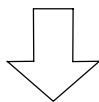
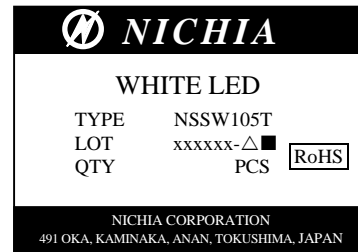

The box is partitioned with the cardboard.

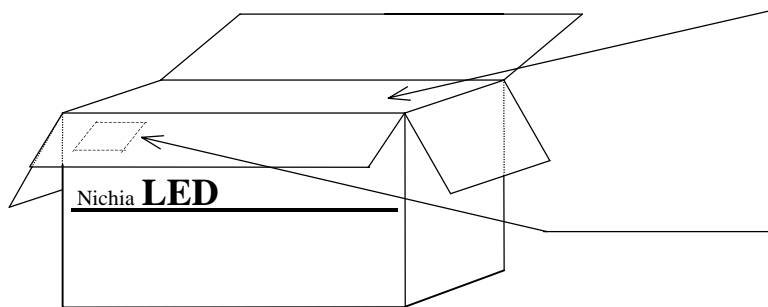

Label



Packing unit

	Reel/bag	Quantity/bag (pcs)
Moisture proof foil bag	1reel	5,000 MAX.

Cardboard box	Dimensions (mm)	Reel/box	Quantity/box (pcs)
Cardboard box S	291×237×120×8t	5reel MAX.	25,000 MAX.
Cardboard box M	259×247×243×5t	10reel MAX.	50,000 MAX.
Cardboard box L	444×262×259×8t	20reel MAX.	100,000 MAX.

NICHIA CORPORATION	Model	NSSW105T	/
	Title	PACKING	
	No.	070705768451	